

# Autodesk Simulation Mechanical for the Construction Industry

James Herzing – Simulation Evangelist - Autodesk Inc.

## SE2382 - Autodesk® Simulation Mechanical for the Construction Industry

### Learning Objectives

At the end of this class, you will be able to:

- Get insight into the structural performance of an assembly
- Study the effect of pre-stressed bolts on your assemblies
- Simulate structure failures to understand why they failed
- Set up a global model with critical local detail
- Understand how to setup a fabrication construction
- Run design optimization and fatigue analyses

### About the Speakers

#### James Herzing

James Herzing has been using the Autodesk Simulation software for nearly 9 years, working in various positions that deal with customer issues, and trying to ensure their success. Currently, he works as part of the Industry Strategy and Marketing division as a member of the Go-to-Market team. He graduated from the Pennsylvania State University in 2004 with a BS in Mechanical Engineering and a minor in Engineering Mechanics. He has presented in 9 Autodesk University classes, and is hosting or assisting in 5 at this year's Autodesk University.

For any questions, feel free to reach us at:

[James.Herzing@autodesk.com](mailto:James.Herzing@autodesk.com)

### General Construction Analysis Techniques

#### Opening the CAD geometry and applying bolts

In this exercise, we will start with the model open in Autodesk Inventor, and then send it automatically to Autodesk Simulation Mechanical. This will allow us to not only import the

geometry, but to keep associativity in the model in case any geometry changes need to be made after analyzing and finding necessary changes.

1. **Open** the model inside of Autodesk Inventor.
2. Click on the Autodesk Simulation tab and choose the **Launch Active Model** button.
3. With the model in Simulation Mechanical, choose the Analysis Type to be **MES with Nonlinear Material Models**.
4. In the Mesh tab, click on the **Bolt** button in the CAD Additions panel.
5. Define the **bolt diameter** to be **20mm**, the number of **spokes** to be **16**, the **head diameter** to be **30mm** and the **nut diameter** to be **30mm**.
6. Choose **Surface 14 of Part 3** for the bolt head surface and click **Add**.
7. Choose **Surface 19 of Part 1** for the nut surface and click **Add**.
8. Choose **Surface 7 of Parts 1 and 3** for the interior and click **Add**.
9. Apply an **Axial Force** of **100000N** and click **OK**.
10. Repeat for remaining holes.

### Meshing the CAD geometry

1. Click on the Mesh tab and click the **Generate 3D Mesh** button.
2. Select **Parts 1 and 3** in the model tree, right click and choose **CAD Mesh Options: Part**.
3. Click on the **Options** button and define the absolute mesh size to be **6.66mm**.
4. Click **OK** twice.

### Defining Materials and Element Definition

1. Select **Parts 1 – 4**, right click and choose **Edit: Materials**.
2. Choose **AISI 1020 Steel**, cold rolled and click **OK**.
3. Select **Part 5**, right click and choose **Edit: Materials**.
4. Choose **ASTM – A514** in the material library and click **OK**.
5. Choose Part 1, right click and choose **Edit: Element Definition**.
6. Choose **von Mises with Isotropic Hardening** and click **OK**.
7. Click **Generate 3D Mesh**.

### Create contact pairs between parts

1. Select Part 1 and 3, right click and choose **Contact: Create Contacts Between Parts**.
2. Right click on the new contact pair and change from Default to **Surface Contact**.

## Apply loads and boundary conditions

1. Click on the Setup tab, and choose **Force** from the Loads panel.
2. Choose the surface at the end of the cantilever.
3. Choose the **Z radio button** and enter a magnitude of **-20,000N**.
4. Activate the check box next to **Follows moving surface**.
5. Click on the **curve** button and enter values matching the table below.

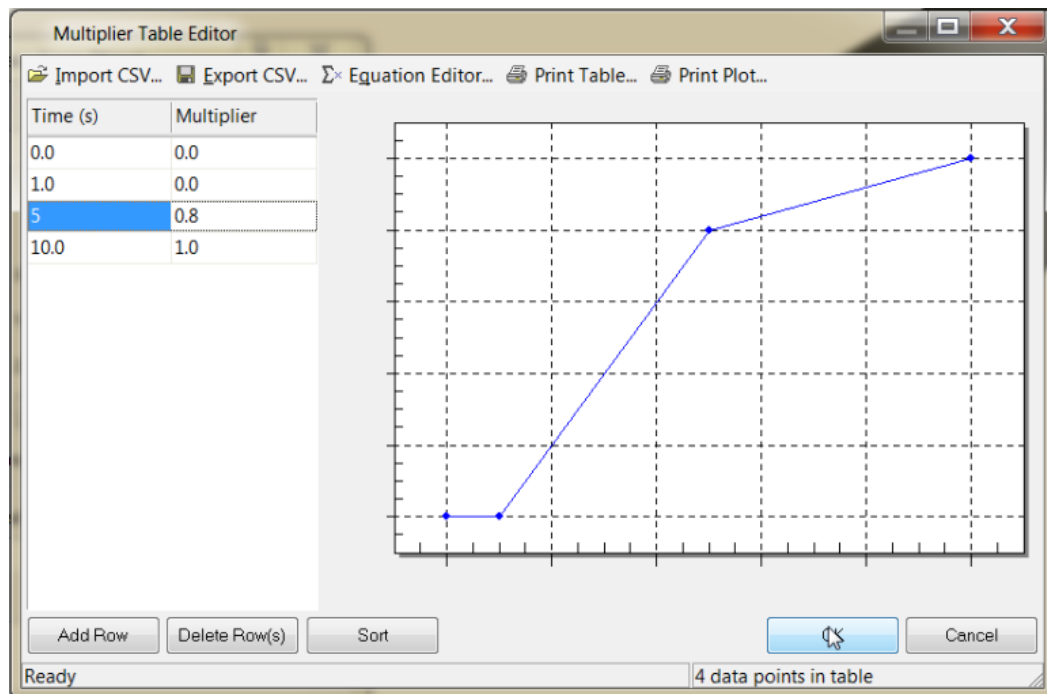

6. Click **OK** twice.
7. Choose **Moment** in the Loads panel.
8. Enter a magnitude of **2e7N\*mm**.
9. Choose the **Y radio button** and click **OK**.
10. Select the bottom surface of the blue beam.
11. Click on **General Constraints** from the Constraints panel.
12. Choose **Fixed** and click **OK**.

## Define Analysis Parameters

1. Click on the Setup tab and choose **Parameters** from the Model Setup panel.
2. In the Event tab, click **Insert Row**.
3. Input values to make values match those in the table below.

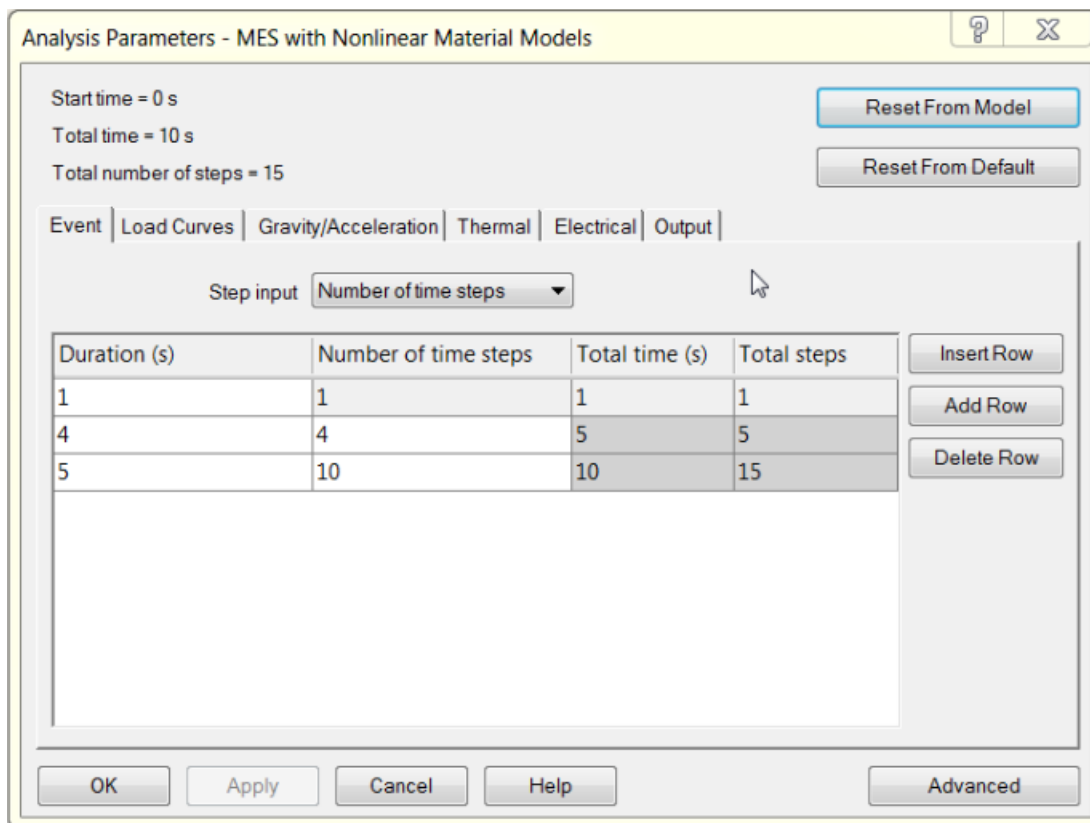

4. Click **OK**.

### Analyzing the model

1. Click on the Analysis tab.
2. Click the **Run Simulation** button from the Analysis tab.

### Review Results

1. Review the **Displacement** for the various time steps of the analysis.
2. Click on **von Mises** from the Stress panel.
3. Review the results of the first two time steps.
4. Click on **Smooth Results** from the Settings panel.
5. Click on **Beam and Truss: Axial Stress** from the Stress panel.
6. In the model tree, right click on Part 1 and choose **Isolate**.
7. Determine the region of maximum stress, using the **Results Inquire** options.
8. Right click on part 3 and choose **Visibility**.
9. With displacement being shown, select the node in the top center of the I-beam, right click and choose **Graph**.

## Structure Erection Analysis

### Importing the CAD geometry to Simulation Mechanical

In this exercise, we will again start with the model open in Autodesk Inventor, and then send it automatically to Autodesk Simulation Mechanical. We will include the importing of work points so that we have locations for us to connect beam elements too easily.

1. **Open** the model inside of Autodesk Inventor.
2. Click on Autodesk Simulation and press **Launch Active Model**.
3. When asked to import work points, choose **Yes**.
4. Choose **MES with Nonlinear Material Models** as the analysis type.

### Define contact between parts

1. Select Part 1, right click and choose **Suppress**.
2. Select Parts 3 and 4, right click and choose **Contact: Generate Contact Between Parts**.
3. Select Parts 2 and 4, right click and choose **Contact: Generate Contact Between Parts**.
4. Choose the two new contact pairs in the model tree, right click and choose **Surface**.
5. Repeat the surface contact procedure for the surfaces shown below.

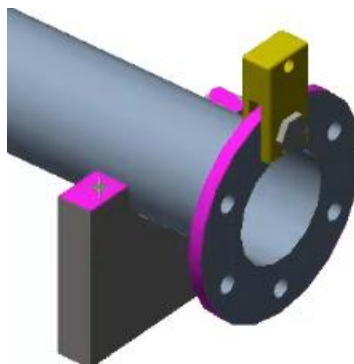

### Meshing the model

1. Click on the Mesh tab and pick **3D Mesh Settings**.
2. Move the slider to **75%** and choose Mesh model.
3. Click **OK** after successfully meshing.

4. Choose Part 4, right click and pick **Edit: Element Definition**.
5. Choose to include **midside nodes**.

### Create joints in lifting holes

1. Select the surface shown in the image below.

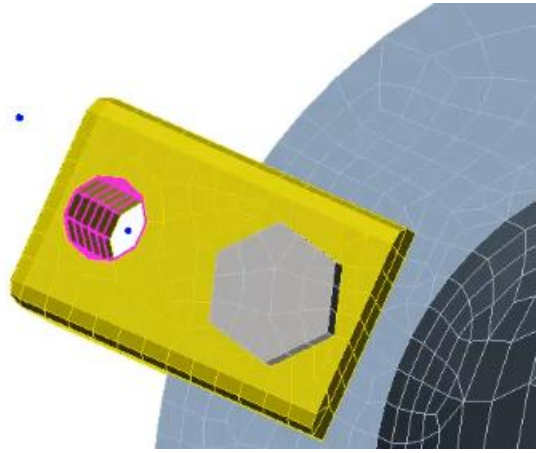

2. Click on the Mesh tab, and choose **Joint** from the CAD Additions panel.
3. Choose **Universal Joint** and click OK.
4. Repeat the process for the hole in the other lifting fastener.
5. Select the Element Definition for Parts 9 and 10.
6. Right click and choose **Edit: Edit Element Definition**.
7. Input a cross-section of  $1 \text{ in}^2$  and click **OK**.
8. Select the material for Parts 9 and 10, right click and choose **Edit: Material**.
9. Pick **Steel (ASTM – A36)** and click **OK**.

### Draw lines to lift model from

1. Select Parts 5 and 8, right click and uncheck **Visibility**.
2. Click on the Draw tab, click Line in the Draw panel.
3. Change the part number for the line to be 11.
4. **Draw** lines connecting in the areas shown in the image below.

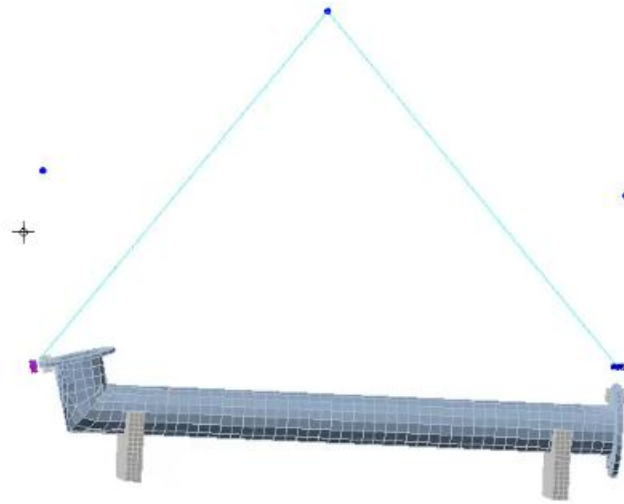

5. Right click and choose **Edit: Edit Element Definition**.
6. Input a cross-section of **1 in<sup>2</sup>** and click **OK**.
7. Select the material for Parts 9 and 10, right click and choose **Edit: Material**.
8. Pick **AISI Type 304 Stainless Steel** and click OK.
9. Select **Part 11**, right click and choose **Select Sub entities**.
10. Right click and choose **Divide**.
11. Enter **10** into the field and click **OK**.

### Apply loads and boundary conditions

1. Click on **Selection** and choose **Rectangle** and **Vertices**.
2. Box select the nodes on the bottom of the parts connected to the truck.
3. Click on **Setup: General Constraints** and pick **Fixed**.
4. Select the nodes at the end of each as shown in the image below.

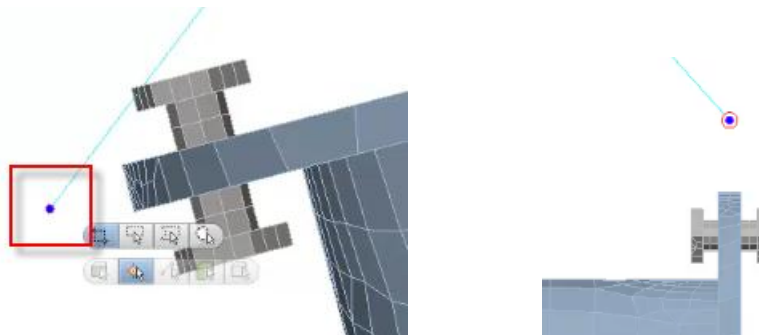

5. Choose **Setup: General Constraints** and activate the checkbox next to **Tz**.
6. Click **OK**.
7. Choose the node at the top where the two lines come together.
8. Choose **Setup: General Constraints** and activate the checkbox next to **Tx** and **Tz**.
9. Click **OK**.
10. On the same node, click on **Prescribed Displacement** from the Constraints panel.
11. Enter a magnitude of **36 in**.
12. Activate the **Scalar Y** radio button.
13. Click on the **Curve...** button and make the curve look like the image below.

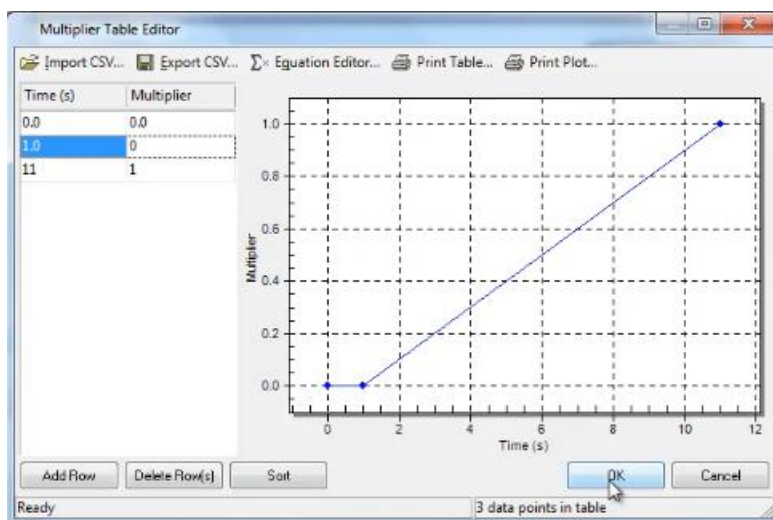

14. Click **OK** twice.

### Defining Analysis Parameters

1. From the Setup tab, click on **Parameters** from the Model Setup panel.
2. Make the table in the Event tab look like the image below.



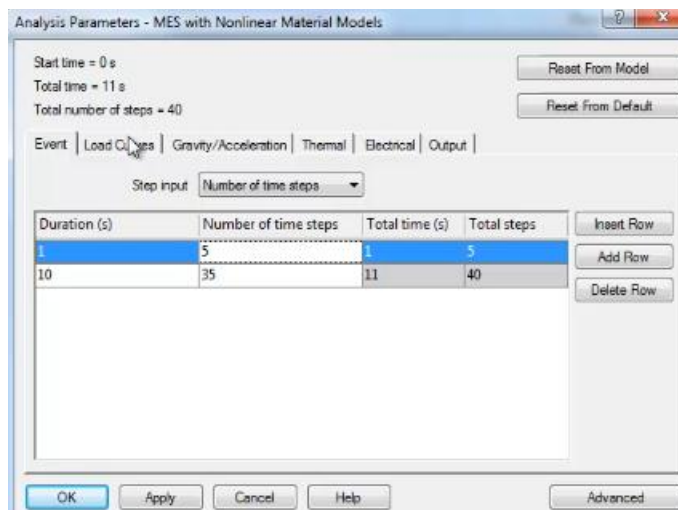

3. Click on the **Load Curves** tab.
4. Click the **Add** next load curve... button.
5. Make the new load curve look like the image below.

Load Curve			
	Index	Time (s)	Multiplier 1
	1	0	0
	2	1	1
	3	11	1

6. Click on the **Gravity** tab.
7. Press **Set for standard gravity**.
8. Type a **-1** in the **Y** multiplier and a **0** in **Z** multiplier.
9. Click **OK**.

### Analyzing your model

1. Click **Save As** and give this file another name.
2. Click on the Analysis tab.
3. Press **Run Simulation** from the Analysis Panel.

Since we are running this model with Simulation Mechanical 360, we will disconnect from the analysis while it solves and setup another version to analyze.

### Applying new line elements for the second analysis

1. Select the lines of **Part 11** and choose to **delete**.
2. **Draw** the new lines to look like the image below. (make sure the line parallel to the CAD model is created on **Part 12**)

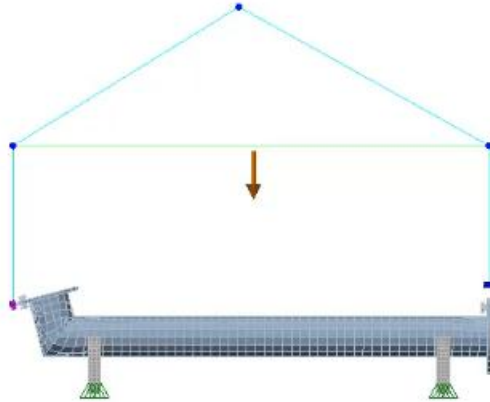

3. Select the lines of **Part 11**, right click and choose **Divide**.
4. Enter **10** into the field and click **OK**.
5. Right click on the Element Type of **Part 12** and choose **Beam**.
6. Right click on Element Definition and choose **Edit: Element Definition**.
7. Click on Cross-Section, and choose **Pipe**.
8. Enter an **outer radius of 4in** and an **inner radius of 3.75in**.
9. Click on **OK** twice.
10. Choose to **edit** the **material** of **Part 11** and choose **Steel (ASTM - A36)** and click **OK**.

### Applying new loads and boundary conditions

1. Select the nodes shown in the image below.

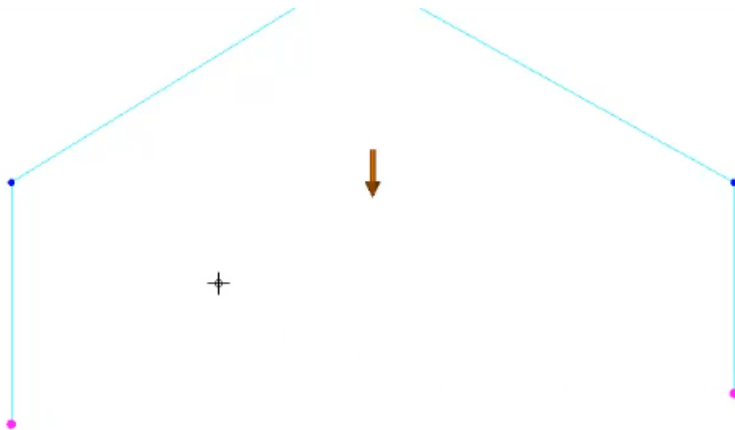

2. Click on **Setup: General Constraint**.
3. Activate **Tz** and click **OK**.
4. Choose the top node and select **General Constraint**.
5. Activate **Tx** and **Tz**, and click **OK**.
6. With the same node selected, click on **Prescribed Displacement**.
7. Enter a magnitude of **36in** and click the **Scalar Y** radio button.
8. Click **OK**.

### Analyzing your model

1. Click on the **Analysis** tab.
2. Press **Run Simulation** from the Analysis Panel.

### Review your results

We will start by looking at the results of our first analysis to determine how it will displace and if it will yield, and then compare them to the second analysis.

1. Review the various time steps to see the **Displacement** values.
2. Click on **von Mises** in the Stress panel.
3. Click on **Safety Factor** in the Stress Panel.
4. **Open** the second analysis.
5. Review the various time steps to see the **Displacement** values.
6. Click on **von Mises** in the Stress panel.
7. Click on **Safety Factor** in the Stress Panel.

## Design Optimization and Fatigue

### Importing the CAD geometry to Simulation Mechanical

1. **Open** the model inside of Autodesk Inventor.
2. **Delete** all parts except Tie Rod:1, Tie Rod Bolt:1, Top Right Tie Rod End:1 and End Link:2.
3. Click on Autodesk Simulation and press **Launch Active Model**.
4. Choose the analysis type to be **Static Stress with Linear Material Models**.

### Meshing the model

1. Click on **Mesh: 3D Mesh Settings** from the Mesh panel.
2. Click on the **Options** button.
3. Change the number of **retries to 0**.
4. Click on Model and uncheck the box next to **Use virtual imprinting** and **Use automatic geometry-based mesh size function**.
5. Click **OK**, move the slider to **50%** and press Mesh model.

### Apply loads and boundary conditions

1. Select the **Tie Rod Bolt** surface.
2. Click on **Setup: General Constraints** from the Constraints panel.
3. Click **Fixed** and press **OK**.
4. Select the **bottom** of the **End Link**.
5. Press **Force** from the Loads panel.
6. Apply a magnitude of **50 lbf**.
7. Choose **vector** and make the direction perpendicular to the surface.
8. Click **OK**.

### Defining the Parametric Study and Analyzing

1. From the Select tab, click on **Parametric Study** in the Model Setup panel.
2. Click the checkbox next to **d0** under **Tie Rod:1**.
3. Click **next** to Setup/Run.
4. Enter a value of **1.5, 1.4, 1.3, 1.25 and 2**.
5. Press the **Run** button.
6. Review the scenarios to determine the best design.
7. Choose that design and press **Run Simulation** from the Analysis tab.

After analyzing, you can now review your results to determine the displacement, stress and factor of safety. Once we determine that the model is safe, we can run a fatigue analysis to determine how many cycles the part can handle.

### Run a Fatigue Analysis

1. Click on the Analysis tab and press **Fatigue Analysis**.
2. Click the radio button next to **Stress Based** and press **Next**.
3. Click on the **material** button and choose the first option. Click **OK**.
4. Uncheck the box next to **My material is a Steel** and click **Next**.

5. Click the check box next to **Surface Finish** and choose **Polished**.
6. Click **OK** and **Next**.
7. Click on the **load curve** and enter the values as shown below.

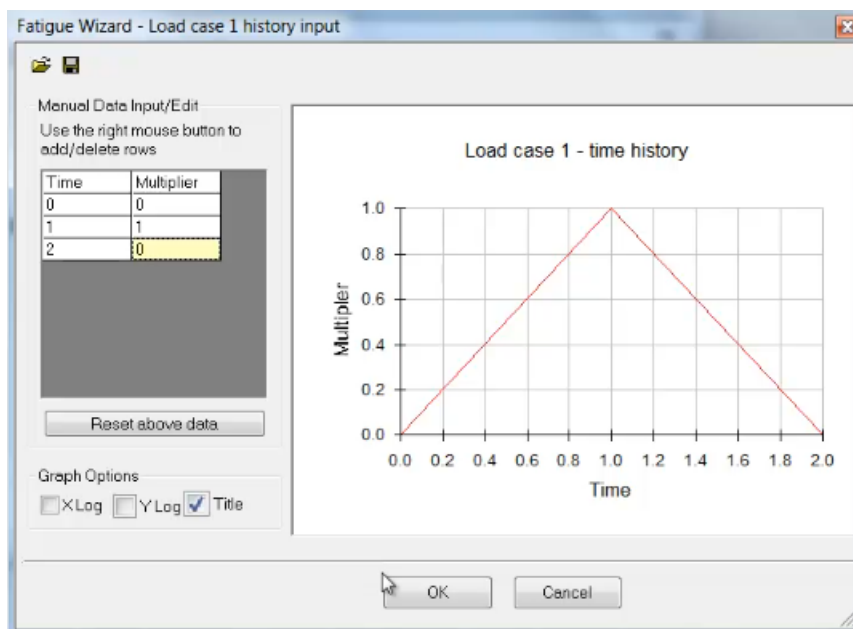

8. Click **OK** and **Next**.
9. Select the number of cycles you want to analyze for and press **Next**.
10. Press the **Analysis Start** button and review the results.

## Environmental Loading

### Applying Loads and Boundary Conditions

1. Select the bottom and four sides of the base.
2. Click the **Setup** tab and choose **General Constraint**.
3. Click **Fixed** and press **OK**.
4. Select the top of the shade and apply a **Pressure**.
5. Enter a Magnitude of **25 psf** and press **OK**.

### Applying Loads and Boundary Conditions

1. Select Parts 5 and 6, right click and choose **Contact: Create Contact Between Parts**.
2. Right click on the contact pair created and change it to **Surface** contact.
3. Click on **Parameters** from the Setup tab.
4. Make the **Load Case Multipliers** table look like below.

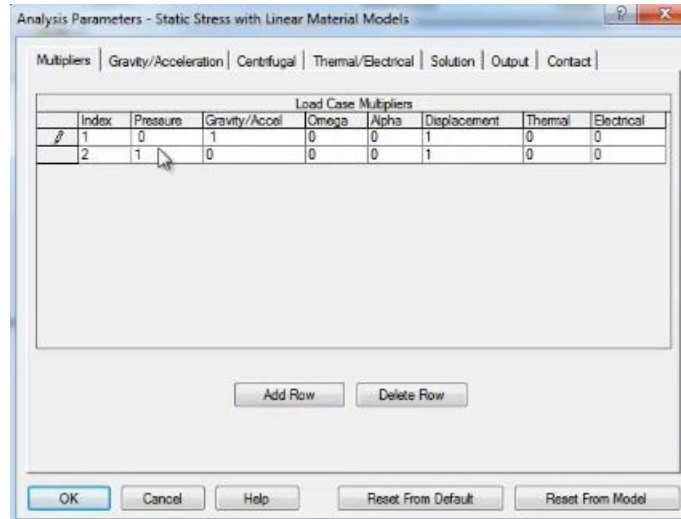

5. Click the **Gravity/Acceleration** tab.
6. Click **Set for standard gravity button**.
7. Enter a **-1** multiplier in **Y** and **0** in **Z**.
8. Click **OK** and press **Run Simulation**.

### Modal Analysis

1. Right click and change the Analysis Type to **Modal**.
2. Enter the **Analysis Parameters**.
3. Enter the number of frequencies to be **25**.
4. Click **OK** and **Run Simulation**.

### Response Spectrum Analysis

1. Right click and change the Analysis Type to **Response Spectrum**.
2. Enter the **Analysis Parameters**.
3. Make the parameters look like below.

To create the spectrum, click on Import and browse to the earthquake.csv file. This will import all of the necessary points.

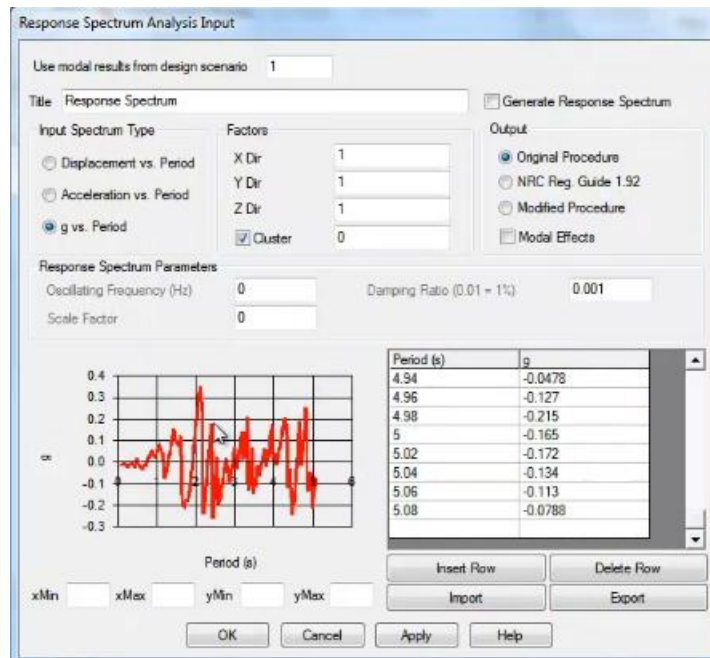

4. Click **OK** and press **Run Simulation**.
5. Review your results.

